



CANEC24021252908

2024 10 09

1 9

15

COB LED

SGS

GZP24-031628

2024 09 24

2024 09 24 ~ 2024 09 29

RoHS	2011/65/EU	II	(EU) 2015/863-
(DEHP)	(PBB)	(PBDE)	(2-)
(DIBP)	(BBP)	(DBP)	

钟臻

Jany Zhong

scan to see the report





CANEC24021252908

2024 10 09

2 9

		SGS ID	
SN1	A15	CAN24-0212529-0001.C015	/ /
SN2	A16	CAN24-0212529-0001.C016	/
SN3	A17	CAN24-0212529-0001.C017	

(1) 1 mg/kg = 1 ppm = 0.0001%

(2) MDL=

(3) ND = (< MDL)

(4) "-" =

RoHS	2011/65/EU	II	(EU) 2015/863-	(PBB)
(PBDE)	(2-)	(DEHP)	(BBP)
(DBP)	(DIBP)			

IEC 62321-4:2013+AMD1:2017 IEC 62321-5:2013 IEC 62321-7-2:2017 IEC 62321-12:2023 ICP-OES/AAS UV-Vis GC-MS

			MDL	A15	A16
(Pb)	1000	mg/kg	2	ND	ND
(Hg)	1000	mg/kg	2	ND	ND
(Cd)	100	mg/kg	2	ND	ND
(Cr(VI))	1000	mg/kg	8	ND	ND
(PBB)	1000	mg/kg	-	ND	ND
(MonoBB)	-	mg/kg	25	ND	ND
(DiBB)	-	mg/kg	25	ND	ND
(TriBB)	-	mg/kg	25	ND	ND
					ND



CANEC24021252908

2024 10 09

3 9

			MDL	A15	A16
(HexaBDE)	-	mg/kg	25	ND	ND
(HeptaBDE)	-	mg/kg	25	ND	ND
(OctaBDE)	-	mg/kg	25	ND	ND
(NonaBDE)	-	mg/kg	25	ND	ND
(DecaBDE)	-	mg/kg	25	ND	ND

(2-



CANEC24021252908

2024 10 09

4 9

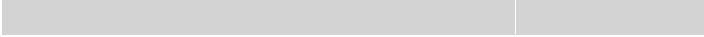

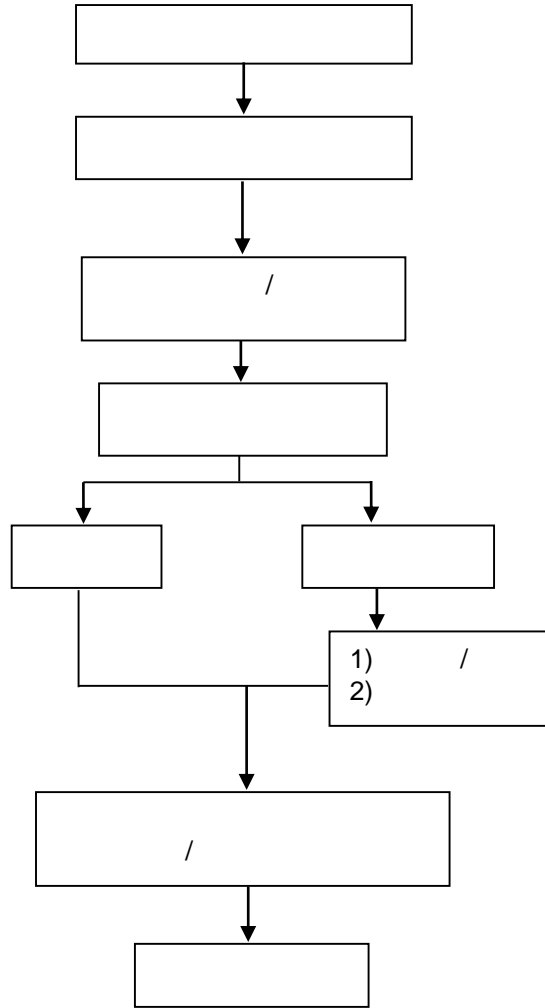

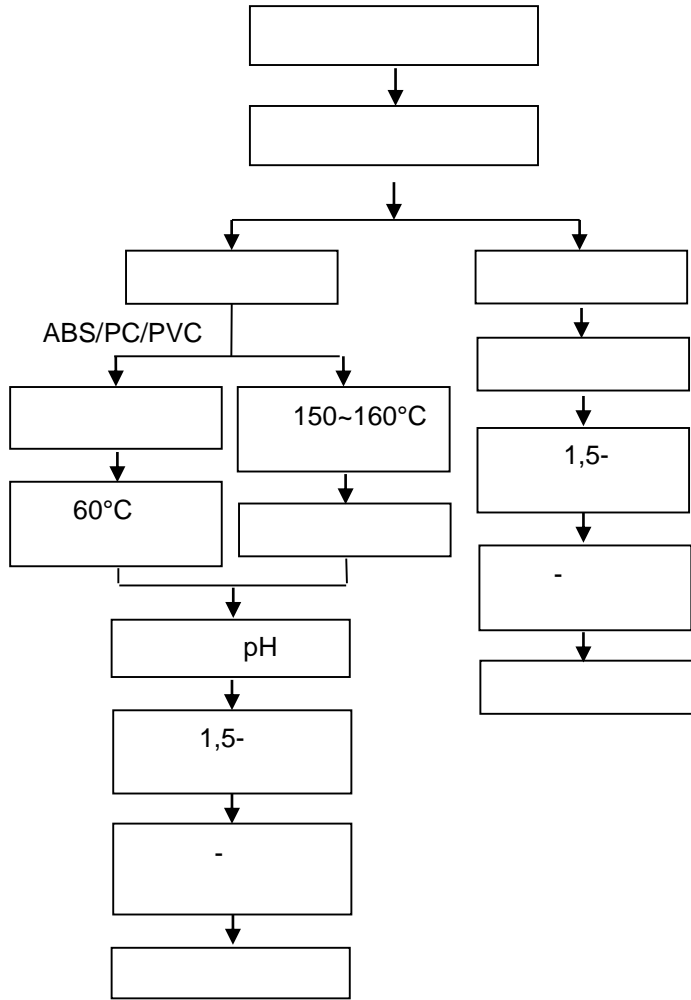



PBB/PBDE/Phthalates

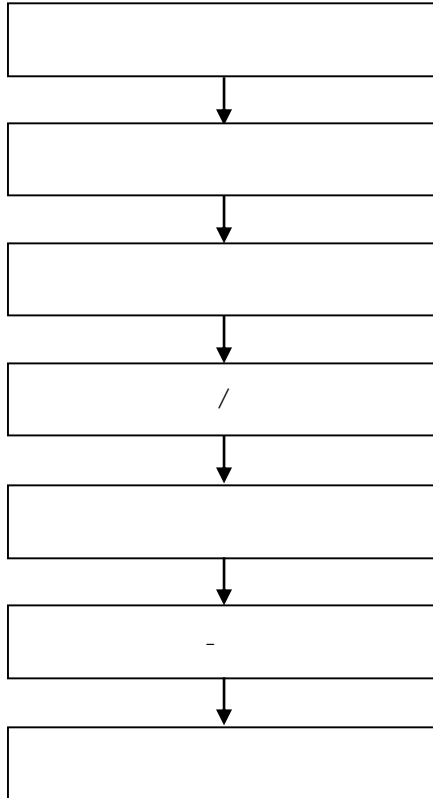

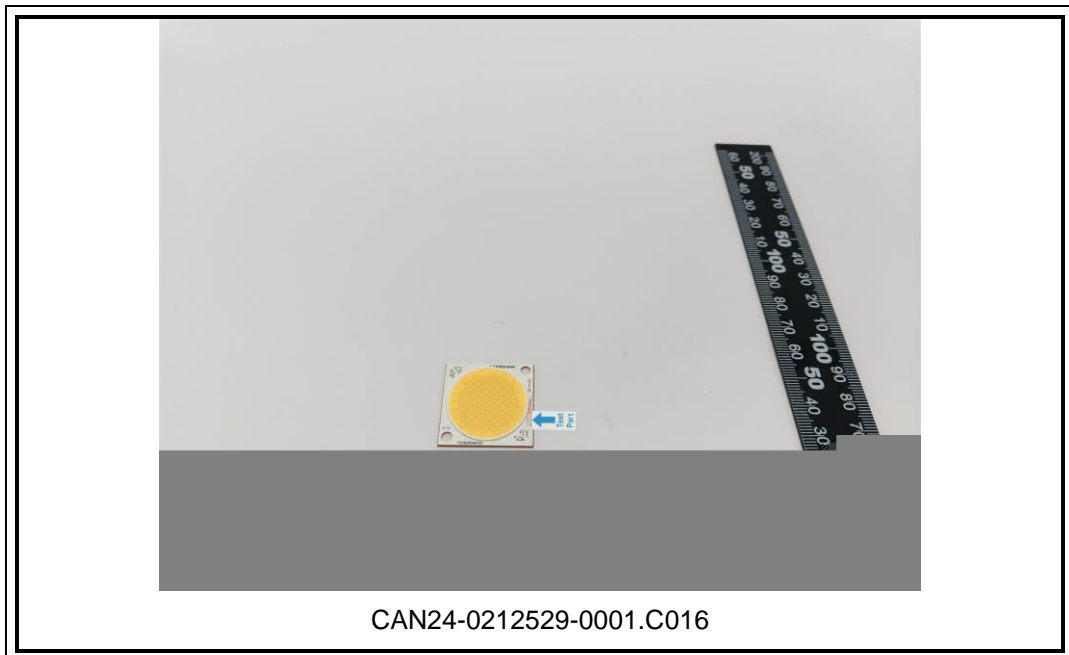
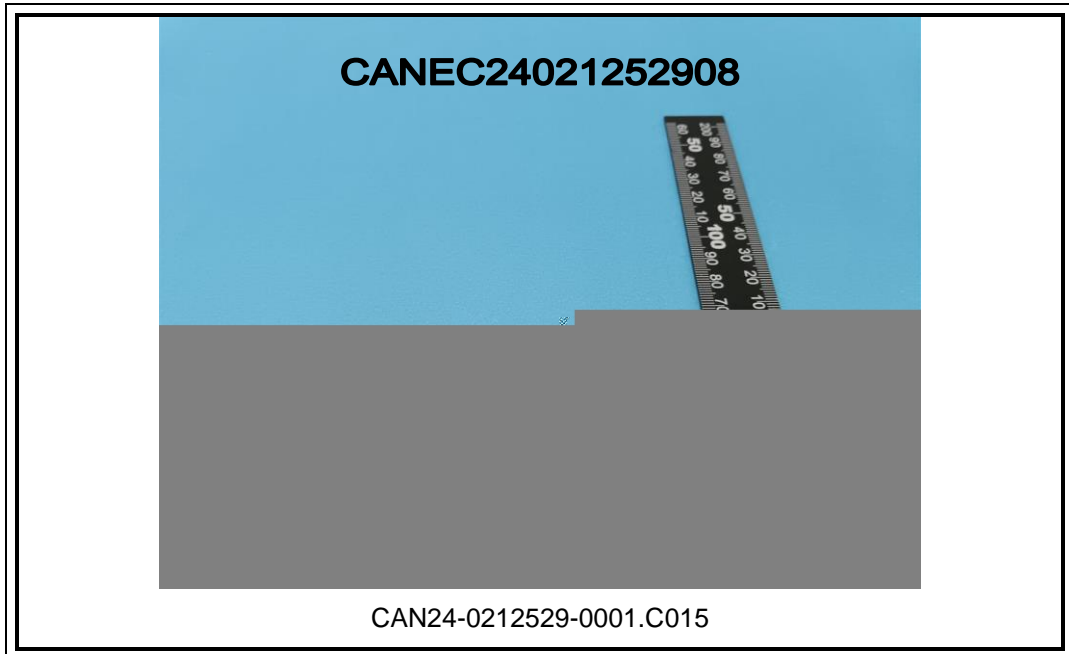



CANEC24021252908

2024 10 09

9

9

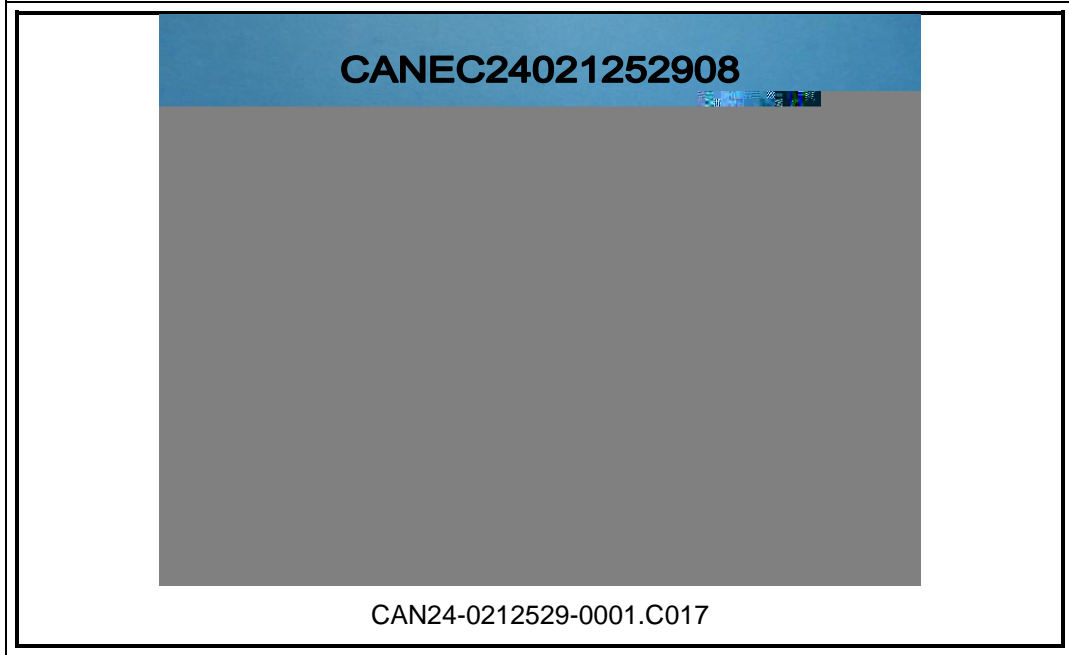

SGS
